

7 SERIES TTV



DEUTZ-FAHR
7230 - 7250 TTV Agrotron





**TOP GERMAN TECHNOLOGY
FOR TOP PRODUCTIVITY.**



7 SERIES TTV AGROTRON	7230	7250
Max. power (kW/HP)	166/226	181/246

Success is achieved by farming enterprises that are able to tackle every task throughout the season, using the lowest possible amount of resources and being effective with the time available. Equally, every penny counts when it comes to reducing production costs - DEUTZ-FAHR has developed the new 7 Series for this type of business. The two new 7 Series models deliver up to 246 HP and stand out for a range of trademark German characteristics: high quality, high precision and reliability combined with cutting-edge technology in terms of both cost-effectiveness and comfort.

The 7 Series represents the culmination of highly innovative and in-

telligent tractor technology manufactured at our new facility in Lauingen Germany. 7 Series is offered with the exceptional comfort of the MaxiVision 2 cab, intuitive controls, a newly designed armrest, state-of-the-art precision farming systems, enhanced with highly efficient engine and transmission technology. Innovative axles and brakes ensure optimal driving comfort and maximum safety. Furthermore, the hydraulic systems and lift capacity both front and rear, compliment the overall 7 Series specification making this tractor the ideal partner for increasing productivity for contractors and agricultural businesses.

DRIVER COMFORT AND OPERATING CONVENIENCE ARE NOT MERE LUXURY, BUT A PREREQUISITE FOR MAXIMUM PRODUCTIVITY. TACKLE WORK BEFORE WORK GETS THE BETTER OF YOU WITH THE NEW 7 SERIES.







**MAXIVISION 2 CAB.
INCREASED PRODUCTIVITY IN A
STRESS FREE ENVIRONMENT..**



The highlights:

- New InfoCenter display in the dashboard cluster
- Quieter, with reduced vibration and incoming heat thanks to the separation between cab and bonnet
- New compact engine hood, providing market leading cab visibility
- Up to 40.000 lumen LED package with four working headlights

The unique features offered by MaxiVision 2 are visible from both the inside and from the outside of the cab. For ease of use and ergonomic factors, the new 7 Series caters for the operator by making best use of the current technology available. The new InfoCentre dashboard display features a 5" colour monitor, providing the driver with a clear stream of data about the tractor's operating conditions, as well as offering maximum convenience in terms of settings and information. Visibility is not compromised in any working conditions, with an option of a 40.000 lumen LED package with four working headlights. Engine noise, vibrations and heat are removed from the operator environment as there is no connection between the cab and engine hood. The new hood encapsulates the latest, highly contemporary look of the DEUTZ-FAHR tractor family, while its compact design also ensures outstanding forward visibility. The best possible view to the rear linkage area is guaranteed by the positioning of the cab.

Other features that help reduce operator fatigue are the welcoming colours of the interior, the large window area, complete with a roof hatch available in three designs: an easy-to-open green roof, a glass roof with



New InfoCenter -both analogue and digital functionality. Top information concept.



Exclusive LED lights with 2.500 lumen per light.



New hood. Maximum view of front implements.



Roof hatch with 3 different configurations.

84% UV radiation absorption and a FOPS safety version for optimal visibility during front loader operation.

The air conditioning system – with automatic function, offers the largest number of air vent outlets in this tractor class guaranteeing uniform air distribution like no other model. Every detail of the MaxiVision 2 cab has been designed to help the driver work for long periods without stress, thus achieving maximum productivity.



**ERGONOMIC OPERATION.
THE INTUITIVE WAY TO
MAXIMUM PRODUCTIVITY.**



PTO controls (front/rear) are conveniently integrated in the armrest...



... along with the front and rear lift controls.



Auxiliary valves are controlled via a joystick with an integrated smart wheel.

The newly designed armrest makes the 7 Series even more intuitive to operate. All routine functions can be automated. Simply pre-select the desired basic settings and activate them at any time with a tap on the screen. The new, highly ergonomic joystick on the armrest, controls everything from driving speed, direction of travel and cruise control selection to the ComfortTip system, rear lift controls and front lift controls.

An intuitive system that requires no change of hand position and no more than a moments thought to operate.

All of the controls are clearly marked with colours and are logically arranged according to their frequency of use. The driver has complete control over the new 7 Series at all times and can work for very long periods at maximum productivity.



NOT A DROP MORE THAN NECESSARY,
BUT NOT A DROP LESS. PRODUCTIVITY
MEANS ACHIEVING THE GREATEST
RESULTS WITH THE FEWEST POSSIBLE
RESOURCES. THE INTELLIGENT SYSTEMS
AVAILABLE ON THE NEW 7 SERIES HAVE
ECONOMY AND ECOLOGY IN MIND.





PRECISION IS THE PREREQUISITE
FOR PRODUCTIVITY.



The highlights:

- 7 Series offers the whole range of DEUTZ-FAHR Precision Farming technology
- iMonitor2 with a 12" display. The largest on the market

The new 7 Series is fitted with the most advanced precision farming technology. The features of the central monitoring and control unit are unique, as are its dimensions: the iMonitor2 has a screen size of 12". Everything runs on a single, clear user interface, from tractor functions to ISOBUS applications, automatic control systems and data management. Two independent cameras can be fitted as an option.

The new 7 Series can also be TIM ready (Tractor Implement Management) and can react to control implements - technology to boost your precision and comfort at work. Another option is the VT4 system. A function that makes it possible to control attachments using the tractor's own functionality, thus avoiding too many implement controls/monitors in the cab. The section control and variable rate control systems for sprayers and seeders are included as standard. Allowing the driver to activate or deactivate sections in order to avoid overlap and to conserve crop protection agents and seed. Thanks to an optional remote control system, product specialists from DEUTZ-FAHR can access vehicle systems remotely when providing support. Of course, there are also automatic control systems as well as solutions for wireless data transmission and data management.



TIM ready (Tractor Implement Management) functions for full implement control.



VT4 ready. Implement functions controlled by the tractor systems.



Section control/ variable rate control as standard.



Wireless data sharing as an option and data management (ISOMXML) as standard.





PRODUCTIVITY DEMANDS A RANGE OF TECHNOLOGICAL SOLUTIONS THAT ACHIEVE THEIR FULL EFFICIENCY WHEN THEY ARE PERFECTLY BALANCED AND WORKING TOGETHER. THE NEW 7 SERIES IS A PRIME EXAMPLE OF THIS.



**TIER 4 SIX CYLINDER
ENGINES. PRODUCTIVITY
POWERED BY EFFICIENCY.**



The highlights:

- Faster reaction speed, higher reserve torque and higher starting torque
- Up to 5% average lower fuel and AdBlue consumption
- Electronic Visco fan for higher cooling efficiency

The new 7 Series is equipped with a completely redesigned engine in terms of environmental impact and cost-effectiveness. The new DEUTZ 6.1 Tier4 Final engine is more responsive, offers higher reserve torque, as well as starting with a higher torque and, at the same time, fuel and AdBlue consumption has been reduced by 5 % compared to the previous generation. The revised exhaust system features SCR exhaust after treatment and an additional, passive DPF (diesel particulate filter). DPF offers three advantages compared to the usual active filters: no fuel injection filter, therefore less heat is generated around the unit and the filter regenerates more quickly. This saves fuel and money while conforming to all international emission standards.

The efficiency of the engine is supported by Electronic Visco fan and the redesigned, compact high-performance cooling system. The patented cooling system can be opened completely, which makes servicing more straightforward. A pre-cleaning system on the air intake slots prevents dirt from entering the air filter, again making a substantial difference to service costs. DEUTZ 6.1 Tier4 Final engine – modern technology made in Germany – is synonymous with the highest levels of know-how and efficiency, allowing you to achieve maximum productivity.

Power, ECE R-120

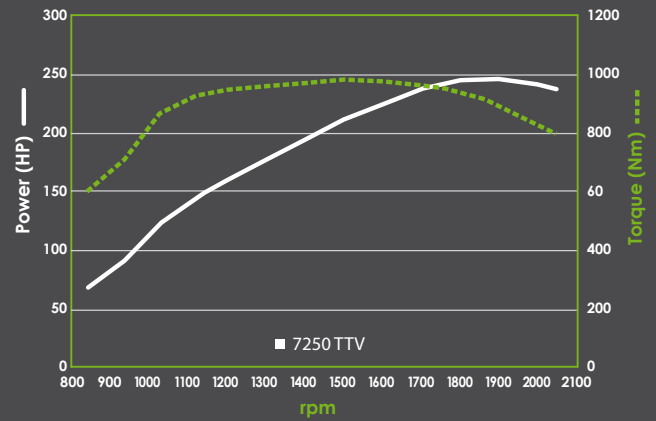

Less fuel and AdBlue consumption. 400 L diesel and 50 L AdBlue tank for long working days.



Newly designed cooling system. Fully openable for easy maintenance.



SCR aftertreatment system and passive DPF (diesel particulate filter) for saving fuel and operating costs.



**TTV TRANSMISSION.
TURN POWER
INTO PRODUCTIVITY.**

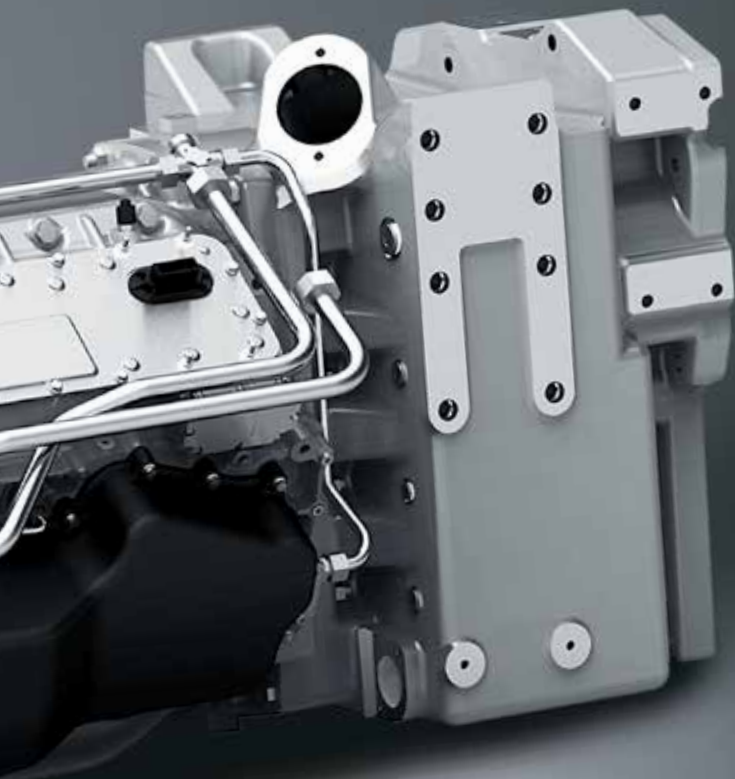

The highlights:

- The only tractor with a compact design capable of enhanced road speeds
- 40 Km/h, 50 Km/h or 60 Km/h at reduced engine speeds
- Intuitive operation with high efficiency

Maximum productivity is the result of precise power transmission and exact working speeds. The new 7 Series is fitted with state-of-the-art electronically controlled continuously variable TTV transmission technology. It is a solid concept that has been tried and tested over the years, now with new software for even better performance. DEUTZ-FAHR is the only manufacturer that offers a 60 Km/h tractor in such a compact design. All final speeds of 40 Km/h, 50 Km/h or 60 Km/h can be reached at a reduced engine speed, which is extremely fuel efficient. Overall, the speed range extends from 0.2 Km/h to 60 Km/h. From field work to road work - the TTV transmission system operates at optimum efficiency in all speeds.

The highly comfortable TTV transmission is extremely efficient thanks to its four mechanical stages, which change automatically. Engine and transmission management are fully integrated, providing a comfortable automatic system for mechanical range shifting. Up to four cruise speeds can be stored in order to optimise work processes. A new trailer stretch mode increases driving safety on hilly terrain. Every single detail of the TTV transmission system has been designed to maximise the productivity of the New 7 Series.



PowerShuttle with SenseShift - 5 levels of reversing sensitivity that can be easily adjusted.



Up to 4 cruise speeds can be memorised to optimise application and efficiency.

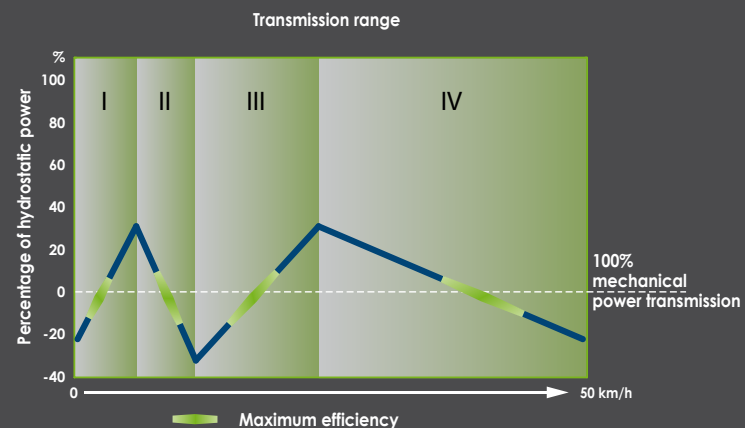



A green tractor is pulling a yellow trailer on a dirt road. The trailer has a ladder on top and the number '15000' on its side. The background is a lush green forest under a blue sky with white clouds. A green diagonal bar is at the top right, containing white text.

PRODUCTIVITY NEEDS MAXIMUM CONTROL – BOTH IN THE FIELD AND ON THE ROAD. AT TOP SPEED, IN CHALLENGING GROUND CONDITIONS AND WITH THE HEAVIEST EQUIPMENT. THE 7 SERIES GIVES YOU CONFIDENCE IN ALL CONDITIONS: SAFETY IN EVERY SITUATION.



**AXLES AND BRAKES.
OPTIMUM PRODUCTIVITY
NEEDS OPTIMUM SAFETY.**

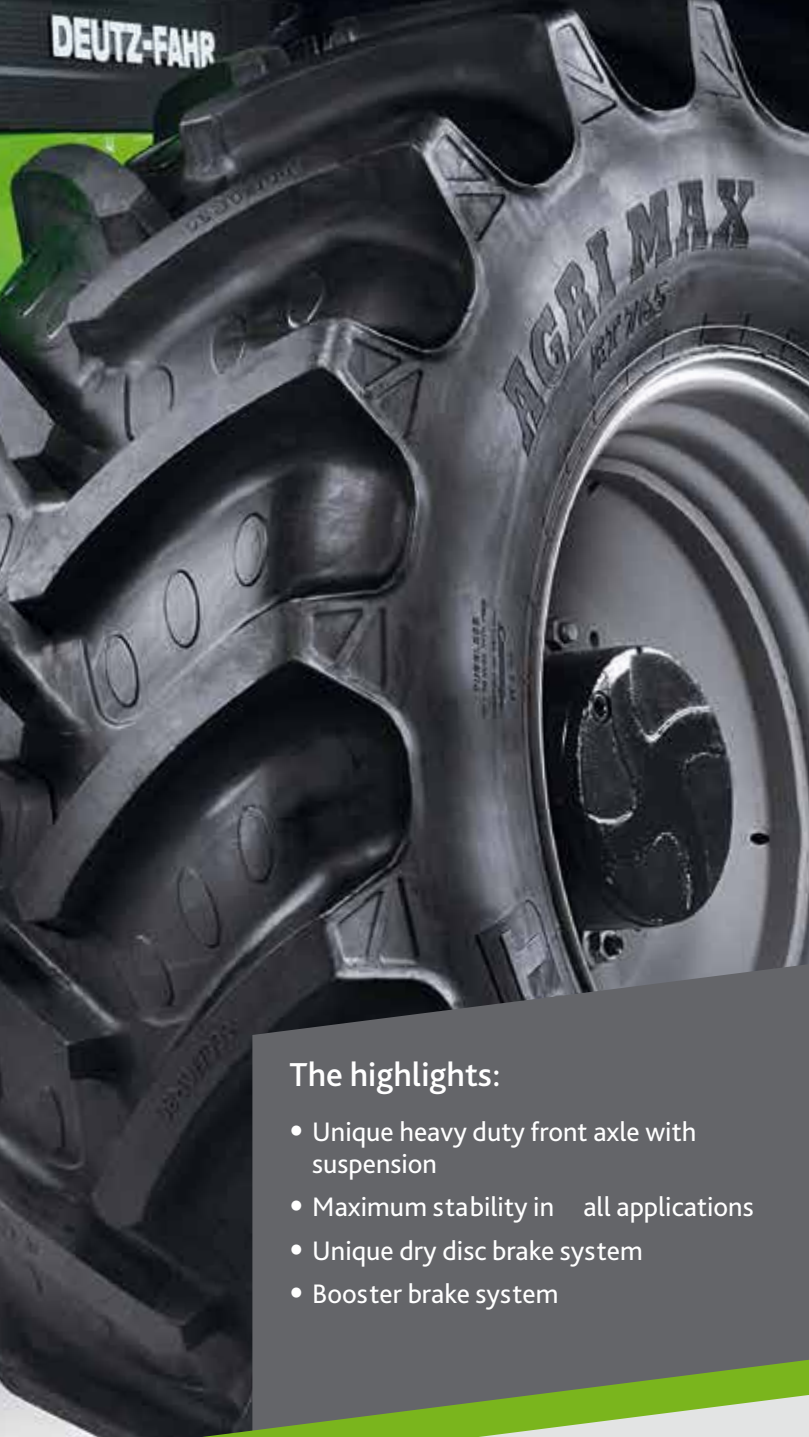

The highlights:

- Unique heavy duty front axle with suspension
- Maximum stability in all applications
- Unique dry disc brake system
- Booster brake system



Unique. The new heavy duty suspended front axle concept.



Booster brake system ensures high braking performance with low pedal force.

The new heavy duty front axle suspension and braking system of the 7 Series are unique in this tractor class. The intelligent and adaptive suspension system give the new 7 Series maximum stability in both heavy towing operations and challenging draft work. The innovative Anti Dive system stabilises the tractor during all transport operations and boosts driving safety. The new suspension design also ensures better handling on uneven ground, with the suspension dampers mounted on the front side of the axle.

The 7 Series is the only standard tractor that is fitted with high performance dry disc brakes on the front axle. The additional Booster brake system ensures maximum braking performance with the lightest pedal pressure. No other standard tractor offers a heavy duty front axle, with dry disc brakes combined with a booster brake system.

THE PRODUCTIVITY OF A TRACTOR DEPENDS DIRECTLY ON THE EQUIPMENT IT CAN DRIVE. SINGLE PASS OPERATIONS REQUIRE INCREASINGLY LARGE AND HEAVY ATTACHMENT COMBINATIONS. THIS IS WHERE THE NEW 7 SERIES CLEARLY DEMONSTRATES ITS STRENGTH.







LINKAGE.
LIFT UP YOUR PRODUCTIVITY.



The highlights:

- All hydraulic valves are proportionally controlled
- Position-controlled front linkage
- New front lift concept - closer positioned linkage and integrated to the tractor
- ISOBUS plug available with front linkage and hydraulic controls

The new 7 Series provides ample auxiliary hydraulic outlets for all applications, with up to five rear spool valves and two front valve options – all proportionally controlled.

The new hydraulic system of the 7 Series offers a front linkage with position control, which until now has only been available on 9 Series. Front lift capacity has been increased to an impressive 5480kg – with the newly integrated front linkage system, machinery is positioned closer to the tractor. The front mounting area also features an integrated ISOBUS terminal.



Up to 7 proportional spool valves at the rear and 2 in the front. Front lift integrated to the tractor and closer coupled



Rear mounted ISOBUS interface..



External control for auxiliary hydraulics, rear lift and PTO mounted on both sides of the tractor.

The standard LS hydraulic system delivers an output of 120 L/min as standard or 160 L/min as an option. A separate pump supplies the steering system so the main working hydraulics are not compromised. The main rear lifting capacity is a generous 10000 kg as standard.

With three PTO speeds (540ECO/1000/1000ECO) at the rear and 1000 or 1000ECO at the front, all PTO operations are covered with maximum efficiency. ECO speeds are achieved with reduced engine speed, and in turn, reduced fuel consumption.

All hydraulic and PTO functions are easily controlled from the armrest in the cab.



IT WAS A LONG JOURNEY.
FROM TILLING THE LAND TO DRILLING
THE SEED, FROM MANAGING THE CROP
TO HARVEST – IT'S A GOOD FEELING
AT THE END OF THE SEASON WHEN YOU
CAN SAY: 'WITH THE NEW 7 SERIES,
I WAS AS PRODUCTIVE AS POSSIBLE'



Technical data		7 SERIES TTVAgrotron	
		7230 TTV	7250 TTV
ENGINE			
Manufacturer		Deutz	Deutz
Model		TCD 6.1 L06	TCD 6.1 L06
Emissions		Stage 4 (Tier4 Final)	Stage 4 (Tier4 Final)
Cylinders/Displacement	n°/cm ³	6/6057	6/6057
Turbo intercooler		●	●
Viscostatic fan		●	●
Deutz Common Rail (DCR)	bar	1600	1600
Max. power (ECE R120)	kW/HP	166/226	181/246
Power at rated engine speed (ECE R 120)	kW/HP	157/214	169/230
Max. homologated power at rated speed (2000/25/EC)	kW/HP	166/226	174/237
Engine speed at maximum power	rpm	1900	1900
Max. engine speed (rated)	rpm	2100	2100
Engine speed at maximum torque	rpm	1600	1600
engine brake		○	○
Electronic engine governor		●	●
Air filter with dust ejector		●	●
Exhaust on cab A-pillar		●	●
Fuel tank capacity	litres	400	400
AdBlue® tank capacity	litres	50	50
TTV TRANSMISSION			
Model		ZF S-Matic S240 / S240HD	ZF S-Matic S240 / S240HD
Number of speed ranges	n°	4	4
Max. speed	Km/h	40/50/60	40/50/60
Overspeed 60 Km/h ECO		●	●
Overspeed 50 Km/h ECO		●	●
Overspeed 40 Km/h SuperECO		●	●
PowerZero		●	●
CruiseSpeed	n°	2+2	2+2
Driving Strategies (Auto/Manual/PTO)		●	●
ECO/Power control		●	●
Hydraulic reverse PowerShuttle		●	●
SenseClutch		●	●
PTO			
PTO 540ECO/1000/1000ECO		●	●
Front PTO 1000		○	○
PTO 1000ECO		○	○
AXLES AND BRAKES			
Suspended front axle		●	●
DT Front wheel drive electrohydraulically engaged		●	●
Electrohydraulically operated differential lock		●	●
ASM system		●	●
Rear braking action with DT engagement		●	●
External disc brakes in the front		○	○
PowerBrake		●	●
Pneumatic trailer brake		○	○
Hydraulic trailer brake		○	○
Bar axle (plug on)		○	○
Automatic Electronic Parking Brake (EPB)		●	●
HYDRAULIC SYSTEM AND HITCH			
Pump output (std)	L/min	120	120
Closed centre hydraulic system (Load Sensing)		●	●
Pump output (opt)	L/min	160	160
Max. usable oil volume	litres	45	45
Separate oil tank		●	●
Auxiliary hydraulic distributors (std)	n° of ways	8	8
Auxiliary hydraulic distributors (opt)	n° of ways	10/12/14	10/12/14
Rear hitch electronic		●	●
Rear electronic lift capacity	kg	10000	10000
Front hitch		○	○
Front lifting capacity	kg	5480	5480

Technical data		7 SERIES TTVAgrotron	
		7230 TTV	7250 TTV
ELECTRICAL SYSTEM			
Voltage	V	12	12
Standard battery	V/Ah/A	12/180/700	12/180/700
Alternator	V/Ah/A	12/200	12/200
Starter motor	V/kW	12/3,1	12/3,1
External power socket		●	●
Implement interface 11786 (7pole)		○	○
Power socket for higher current applications		●	●
CAB			
MaxiVision 2 cab		●	●
Air suspension		○	○
Adjustable rear view mirrors		○	○
Heated and adjustable rear view mirrors		○	○
Air conditioning		●	●
Automatic A/C system		○	○
Openable roof		●	●
Multifunction joystick		●	●
Work Monitor		●	●
Light control panel		●	●
iMonitor2		○	○
Camera system		○	○
Agrosky Ready		○	○
ISOBUS (Class 3) compatible		○	○
Comfortip Professional		○	○
Max Comfort Dynamic Seat XL ++ (dynamic low frequency suspension)		●	●
Max Comfort Dynamic Seat XXL ++ (dynamic suspension, low frequency horizontal suspension)		○	○
Max Comfort Dynamic Seat EVO Active + (active dynamic suspension, wide structure, active A/C system)		○	○
Padded passenger seat		●	●
Radio		○	○
Halogen work lights		●	●
LED work lights (Generation 4)		○	○
TRAILER ATTACHMENTS			
Automatic tow hook		○	○
Height adjustable ball head joint		○	○
Fixed ball head joint		○	○
Oscillating arm		○	○
Pickup hitch		○	○
Piton Fix		○	○
DIMENSIONS AND WEIGHTS			
front tyres		600/70R30	600/70R30
rear tyres		710/70R38	710/70R38
Front tyres		540/65R34	540/65R34
Rear tyres		650/65R42	650/65R42
Wheelbase	mm	2868	2868
Length	mm	4817-4972	4817-4972
Height	mm	3153	3153
Width	mm	2500-2736	2500-2736
Ground clearance	mm	555	555
Front unladen weight	kg	3100-3915	3100-3915
Rear unladen weight	kg	5100-5185	5100-5185
Total unladen weight	kg	8200-9100	8200-9100
rear ballast	kg	○	○
Max. permissible front weight	kg	6000	6000
Max. permissible rear weight	kg	10000	10000
Max. permissible total weight (40 Km/h)	kg	14500	14500

●: standard ○: optional -: not available

Dealer

Marketing-Communication Service - Code 308.8514.3.4-6 - 07/2016. ciagreen

To discover more please contact your dealer
or visit deutz-fahr.com.

DEUTZ-FAHR is a brand of  SDF

